

TIMBER
SASH
WINDOWS

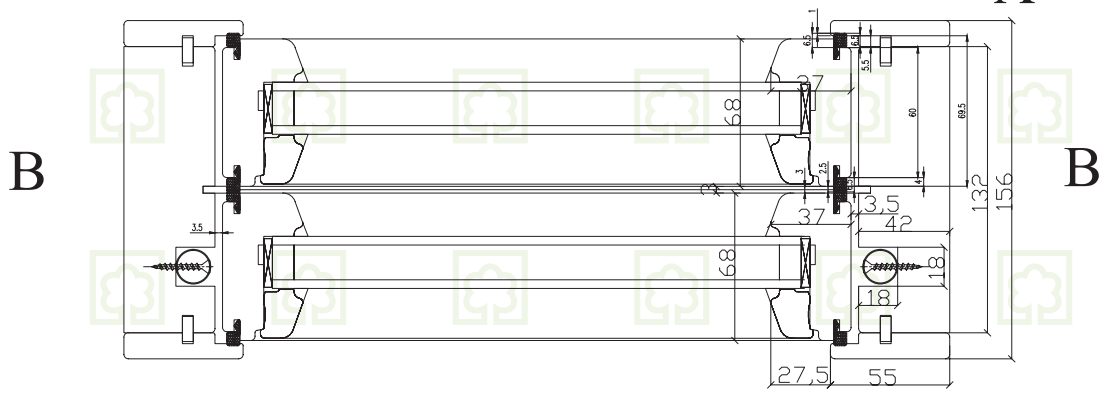

SASH WINDOW

SINGLE SLIDING SASH

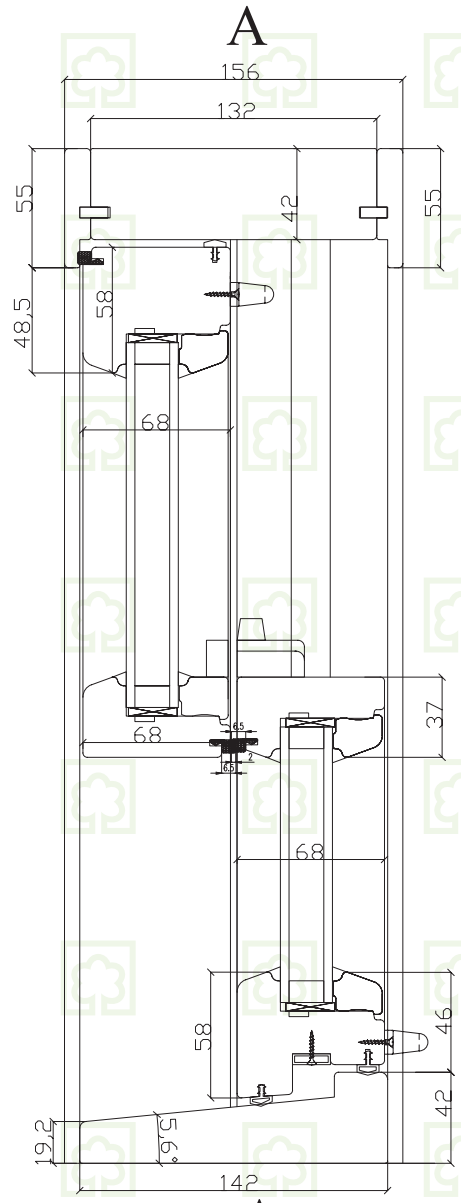
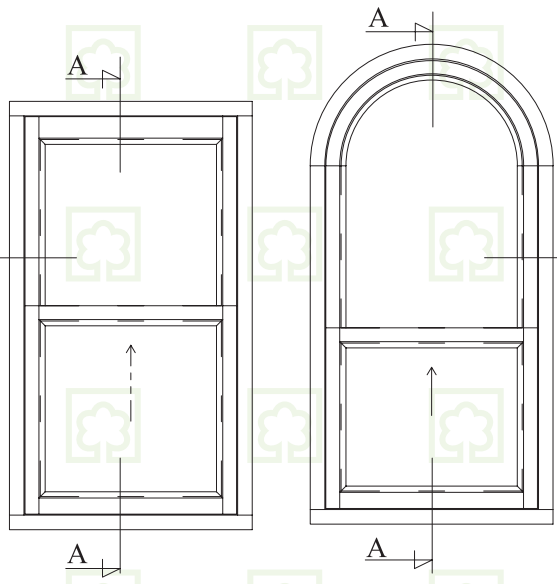

SASH WINDOW

TILT AND SLIDE

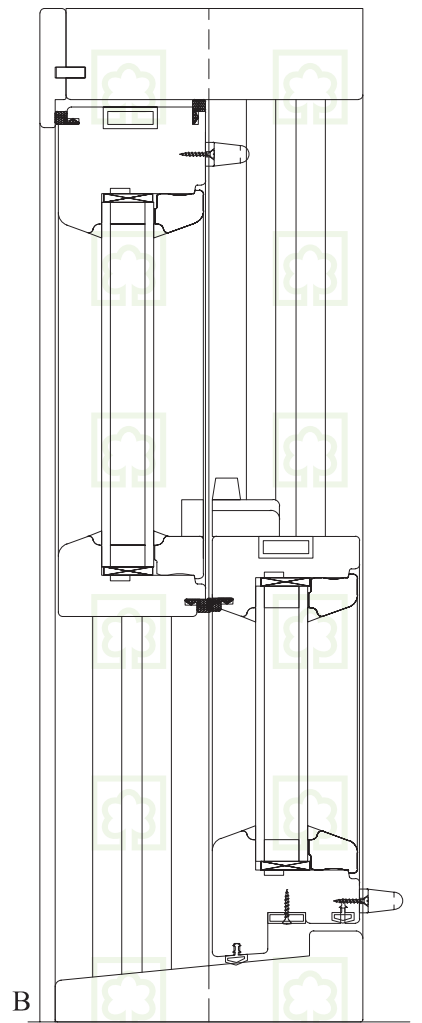
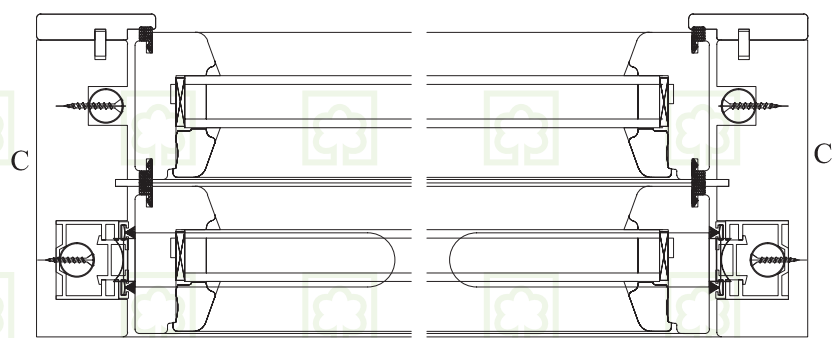
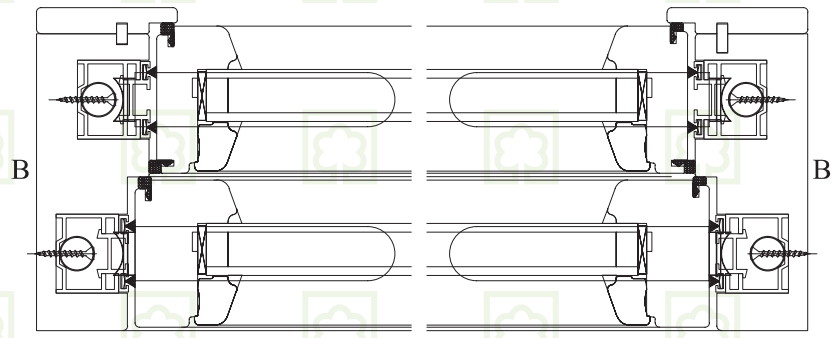
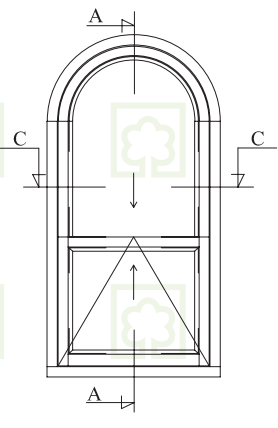
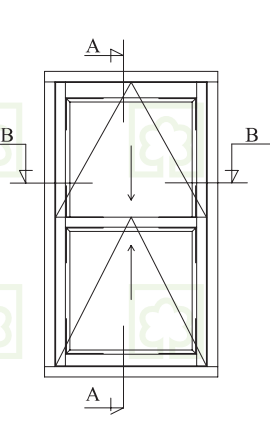

A

A

SASH WINDOWS



MATERIALS:

Wood:

We use laminated scantlings certified FSC or PEFC of

- PINE
- OAK
- RED GRANDIS

All our wood components are treated against insects, fungi and humidity, then stained or painted according to your choice with water based products.

- Stain colours will be selected from our colour chart.
- Any RAL colour may be selected for paints.

Balances:

High-technology mechanisms combining stainless steel rod torsions and tension springs are used in keeping the balance of sashes at any point of its movement.

We also produce timber box sash windows. These are traditional vertical sliders working with weights and cords.

Seals:

- The seals between glazing and profiles are of SILICON.
- The seals are of Q-LON (SCHLEGEL).

IRONMONGERY:

Bow Handles



Cam Lock and Keeps

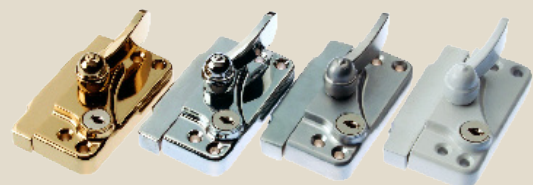

Finger Pulls





ELEGANT LINES

We offer the below options of profiles for use in windows to satisfy different tastes.

EXTERIOR GLAZING BARS AND BEADS

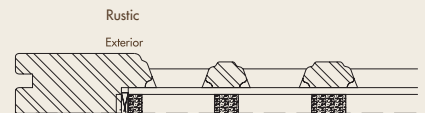

INTERIOR GLAZING BARS AND BEADS

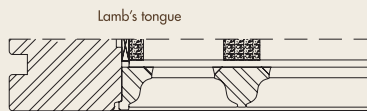
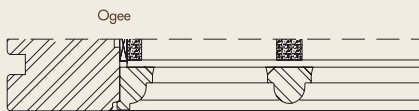
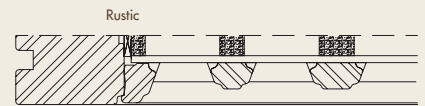
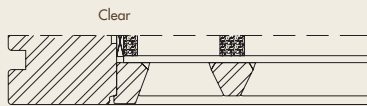
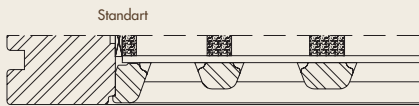

ARBOR Windows Ltd
206, Coloursworks 22-24 Ashwin
Street London E8 3DL ENGLAND
T: +44 (0)789 9247994
www.arborwindows.co.uk

SELECTRON Ltd. Şti.
Atatürk Bulvarı, Köstemir Yolu Cad. No: 74
Silivri 34570 İstanbul / TÜRKİYE
T: +90 212 7360801
www.arbor.com.tr

ARBOR SAS
16 Rue Séjourné
94000 Créteil / FRANCE
T: +33 (0) 1 43 77 56 36
www.arborfenetres.fr